

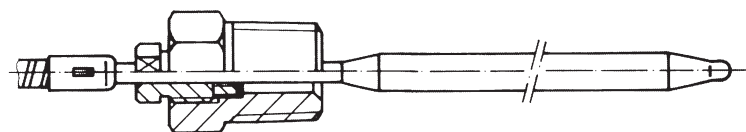

Vgradnji priključki so nadgradnja osnovnemu priključku na instrumentu M 12 x 1,5.

**MATERIAL:** družina 760 AISI 316 Ti  
družina 763 medenina

## PRIMER MONTAŽE

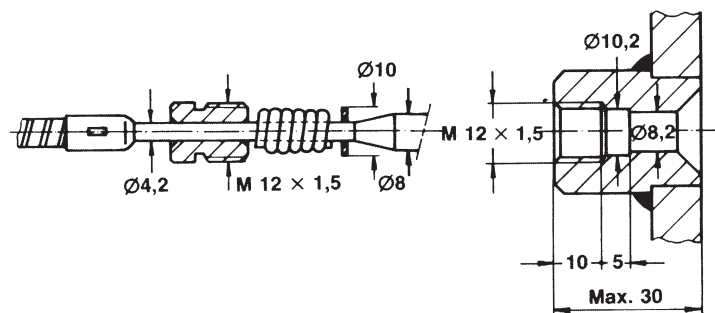

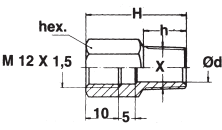
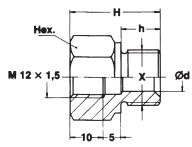
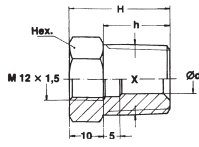
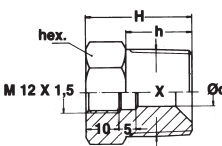
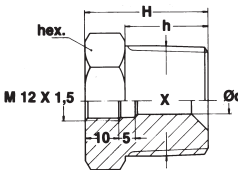
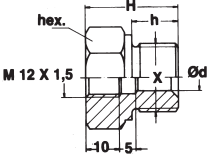
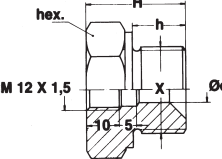
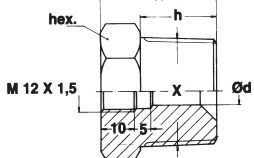
VGRADNA MERA		H	h	d	Hex.
B R 1/4 " konični		30	14	8,2	19
C G 3/8 A		27	12	8,2	22
D 1/2" - 14 NPT		30	20	8,2	22
E 3/4" - 14 NPT		32	20	8,2	27
F 1" - 11 1/2 NPT		37	25	8,2	27
G G 1/2 A		28	14	8,2	27
H G 3/4 A		30	16	8,2	36
I R 1" (konični)		35	23	8,2	36

## PRIMER NAROČILA: 760 D

760 D

- Vgradnji priključek inox 1/2" - 14 NPT